



BH11500

Zvedák s malou světlou výškou s nosností 1.5 t. Mobilní zvedák 1.5T s vysokým zdvihem



PODROBNOSTI O VÝROBKU

- Extra velké oblé pedály jednoduché použití v jakékoliv pozici
- Dvojitý píst snižuje počet potřebných stlačení pumpy o 50 %
- Protiprachový kryt pístu
- Polyuretanová ocelí povlečená kola
- Gumové sedlo
- Zakřivená pohodlná rukojeť
- Odkládací polička pro ukládání drobných předmětů jako náradí, šrouby a matice
- Bezpečnostní tlakový píst proti přetížení
- Bezpečnostní mechanismus pohybu směrem dolů
- Certifikováno dle 2006/42/EC + BS EN1494

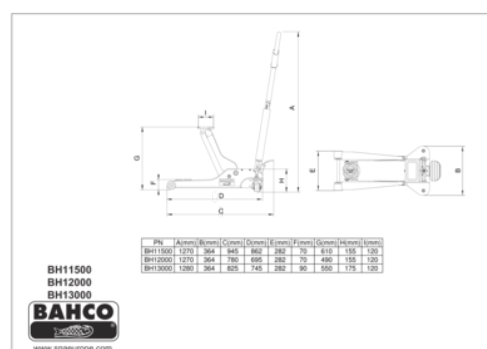











Follow the Fish!



VLASTNOSTI VÝROBKU

Produkt: **BH11500**

	1500 kg		70 mm		610 mm
	862 mm		+/- 10		119 mm
	x		945 mm		364 mm
	1270 mm		48.8 kg		

