



## BH13000

Kompaktní zvedák s nosností 3 t



### PODROBNOSTI O VÝROBKU



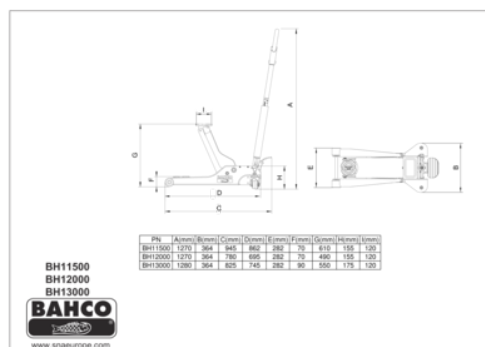







- Velký oblý nožní pedál usnadňuje obsluhu
- Dvojitá pístnice snižuje počet zdvihů o 50%
- Prachový kryt zabraňuje vniknutí prachu a drobných částic do mechanismu
- Gumové sedlo zabraňuje uklouznutí při manipulaci
- Ocelová kolečka potažená PU kombinují dlouhou životnost a tichý chod
- kompozitová zahnutá rukojeť
- Certifikováno dle 2006/42/EC + BS EN1494



Follow the Fish!



## VLASTNOSTI VÝROBKU

Produkt										
<b>BH13000</b>	3000 kg	90 mm	552 mm	825 mm	+/- 11	119 mm	x	X	1280 x 364 x 825 mm	48.5 kg

