

Model No.DUC357 350MM CORDLESS CHAIN SAW

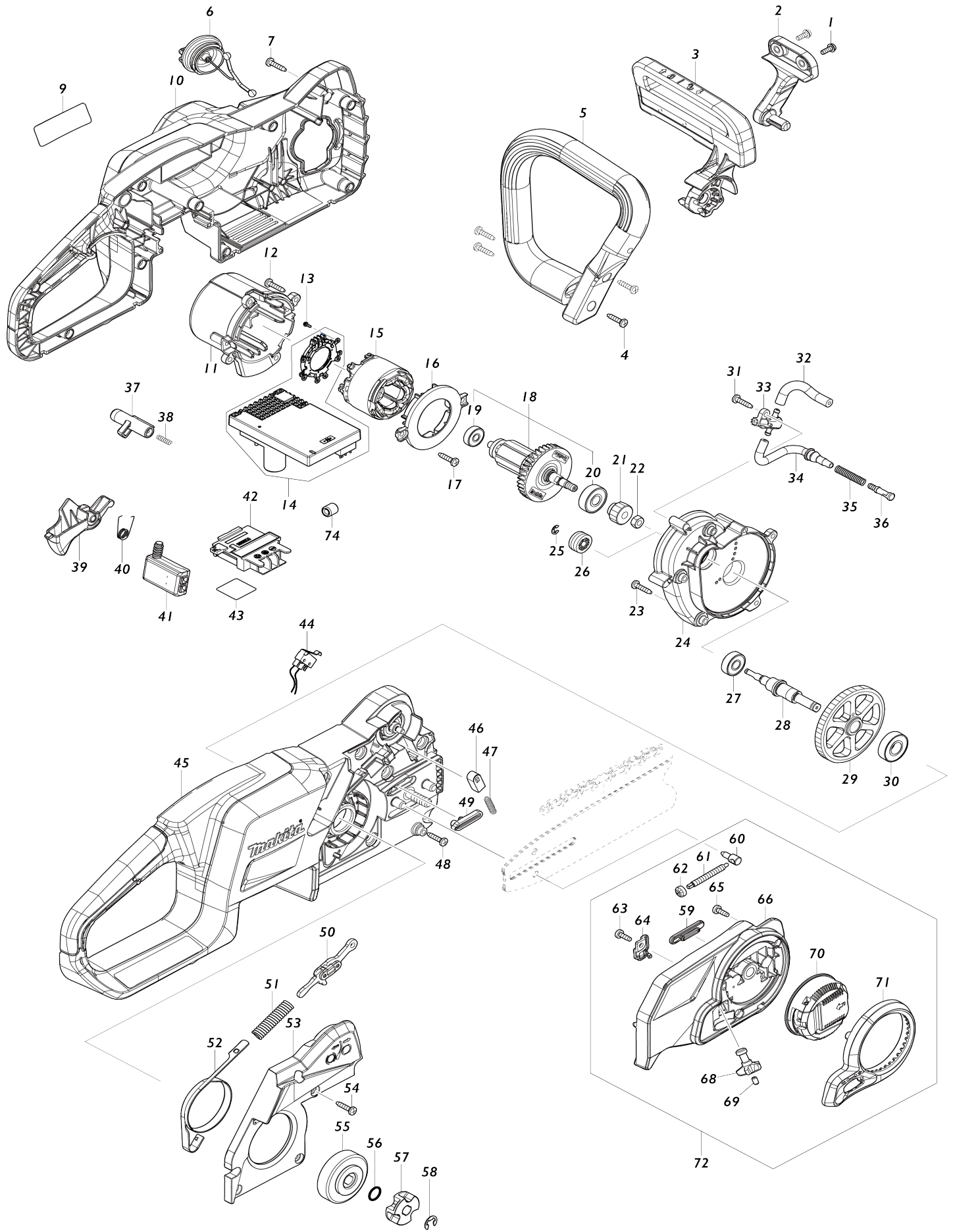

Model No.DUC357 350MM CORDLESS CHAIN SAW

Obj. č.	Obj. č.	Popis	Možnost záměny	Množství	Nový/Stary	Poznámka 1	Poznámka 2
001	911118-1	šroub M4x12		2			
002	413J87-7	FRONT HAND GUARD RETAINER		1		chr	
003	141K82-0	FRONT HAND GUARD COMPLETE		1		chr	
C10	810R21-0	CAUTION LABEL		1			
004	266326-2	šroub 4x18=new265995-6		4	*		
004-1	265B67-9	TAPPING SCREW 4X18	O	4			
005	413J75-4	FRONT HANDLE		1		p	
006	162C20-1	TANK CAP COMPLETE		1		v	
C10	213A30-0	O-RING 29.5		1			
007	266326-2	šroub 4x18=new265995-6		9	*		
007-1	265B67-9	TAPPING SCREW 4X18	O	9			
009	858R06-8	DUC357 NAME PLATE		1			
010	183W84-2	HOUSING SET		1		obal stroje	
C10	263005-3	vymezovací čep 6		2			
C20	8057G1-2	MAKITA LOGO LABEL		1			
010		INC. 45					
011	413J76-2	MOTOR HOUSING		1		sk	
012	266326-2	šroub 4x18=new265995-6		4	*		
012-1	265B67-9	TAPPING SCREW 4X18	O	4			
013	652119-7	PAN HEAD SCREW M2X6		6			
014	620J79-1	CONTROLLER		1		elektronika	
015	629B62-7	STATOR		1		stator	
016	413J86-9	BAFFLE PLATE		1		p	
017	266326-2	šroub 4x18=new265995-6		2	*		
017-1	265B67-9	TAPPING SCREW 4X18	O	2			
018	519766-6	ROTOR ASS'Y		1	*	rotor	
018		INC. 19,20			*		
018-1	519766-6	ROTOR ASS'Y	O	1		rotor	
018-1		INC. 19,20					
019	211499-6	BALL BEARING 626ZZ		1		lo	
020	211092-6	kuličkové ložisko 629DDW		1			
021	227989-9	SPUR GEAR 16		1		ozuben	
022	252186-8	matka 9554-9558		1		matka 9554-9558	
023	266326-2	šroub 4x18=new265995-6		5	*		
023-1	265B67-9	TAPPING SCREW 4X18	O	5			
024	413J72-0	BEARING HOUSING		1		pouzdro lo	
025	961011-9	zajišťovací kroužek		1		zaji	
026	226884-0	WORM GEAR		1		p	
027	211032-4	ložisko 1902		1			
028	327A29-0	SPINDLE		1		v	
029	227990-4	SPUR GEAR 73		1		ozuben	
030	210216-1	BALL BEARING 6001DDW		1		lo	
031	266326-2	šroub 4x18=new265995-6		1	*		
031-1	265B67-9	TAPPING SCREW 4X18	O	1			
032	422914-7	OIL TUBE 3-60		1		olejov	
033	141N25-0	OIL PUMP COMPLETE		1		olejov	
034	422913-9	OIL TUBE 3-105		1		olejov	
035	231975-4	pružina DCS230T/UC3020A=old0		1		pru	

		21245060				
036	452666-6	NIPPLE		1		
037	413J88-5	LOCK OFF BUTTON		1		tla
038	231469-9	compression spring 4		1		compression spring 4
039	413J84-3	SWITCH LEVER		1		sp
040	233621-5	TORSION SPRING 9		1		pru
041	651083-9	SWITCH C3XA-1PSPM		1		vyp
042	643874-2	TERMINAL		1		kontakt
043	858R13-1	DUC357 SERIAL NO. LABEL		1		
044	632L48-2	SWITCH UNIT		1		vyp
045	183W84-2	HOUSING SET		1		obal stroje
C10	263005-3	vymezovací čep 6		2		
C20	8057G1-2	MAKITA LOGO LABEL		1		
045		INC. 10				
046	313212-9	HAND GUARD GUIDE		1		d
047	234210-9	COMPRESSION SPRING 3		1		pru
048	266326-2	šroub 4x18=new265995-6		1	*	
048-1	265B67-9	TAPPING SCREW 4X18	O	1		
049	422915-5	GROMMET		1		te
050	141E60-4	LINK PLATE COMPLETE		1		deska
051	232452-9	COMPRESSION SPRING 7		1		pru
052	347864-4	BRAKE BAND		1		p
053	413J85-1	HOUSING R COVER		1		obal
054	266326-2	šroub 4x18=new265995-6		5	*	
054-1	265B67-9	TAPPING SCREW 4X18	O	5		
055	162B78-4	BRAKE DRUM		1		
056	213060-5	O RING 10		1	*	o-krou
056-1	213A41-5	O-RING 10	O	1		
057	221464-7	SPROCKET 6		1		
058	961013-5	zajišťovací kroužek		1		zaji
059	422833-7	GROMMET		1		t
060	326310-0	ADJUST PIN		1		
061	327958-1	ADJUST SCREW		1		se
062	227496-2	ozubené kolo UC3020A=old2262 13320		1		ozuben
063	266427-6	TAPPING SCREW 4X12		1		
064	413F29-7	COVER		1		kryt
065	266427-6	TAPPING SCREW 4X12		3		
066	413J73-8	SPROCKET COVER		1		
068	142665-3	DRIVE GEAR COMPLETE		1		nap
069	263002-9	vymezovací čep 4		1		
070	142235-8	NUT COMPLETE		1		up
071	454819-3	NUT COVER		1		o
072	136784-5	SPROCKET COVER ASS'Y		1		kryt
072		INC. 59-66,68-71				
074	688164-6	LINE FILTER		1		
A01	191G16-9	GUIDE BAR 14 SET		1		
A02	413G23-5	GUIDE BAR CASE 360		1	*	
A02-1	413G23-5	GUIDE BAR CASE 360	O	1		
A03	191H02-6	SAW CHAIN 14 SET		1		
A06	***DC18RC	DC18RC FAST CHARGER		1		
A06		COMPO-PARTS				

A07	197280-8	BATTERY BL1850B SET		1		
A08	195923-6	ROUND FILE 4.5 SET		1	*	
A08-1	D-70954	FILE HOLDER SET 4.5MM(11/64")	O	1		
E01	891805-7	SOUND 98DB LABEL		1		
F01	191G15-1	GUIDE BAR 12 SET		1		
F02	191G16-9	GUIDE BAR 14 SET		1		
F03	191G17-7	GUIDE BAR 16 SET		1		
F04	191G23-2	GUIDE BAR 12 SET		1		
F05	191G24-0	GUIDE BAR 14 SET		1		
F06	191G25-8	GUIDE BAR 16 SET		1		
F07	191H01-8	SAW CHAIN 12 SET		1		
F08	191H02-6	SAW CHAIN 14 SET		1		
F09	191H03-4	SAW CHAIN 16 SET		1		
F10	191H10-7	SAW CHAIN 12 SET		1		
F11	191H11-5	SAW CHAIN 14 SET		1		
F12	191H12-3	SAW CHAIN 16 SET		1		
F13	195923-6	ROUND FILE 4.5 SET		1	*	
F13-1	D-70954	FILE HOLDER SET 4.5MM(11/64")	O	1		
F14	198457-8	CHAIN EDGER SET		1	*	
F14-1	D-70948	FILE HOLDER SET 4.0MM(5/32")	O	1		

Prosím uveďte objednáací číslo dílu v objednávce

Datum tisku 23. 10. 2024